

Revision Notes.				
-				
APA:	Drawn:-	Checked:-	Approved:-	Date: -

ITEM	PART NUMBER	QTY	MODEL NUMBER	DESCRIPTION
①	4887	1	MDR-404-DS	MAIN RECORDER UNIT GPS AND 32GB SD CARD
②	4888	1	MDR-404-500-MCU	HDD CADDY AND 500GB HDD

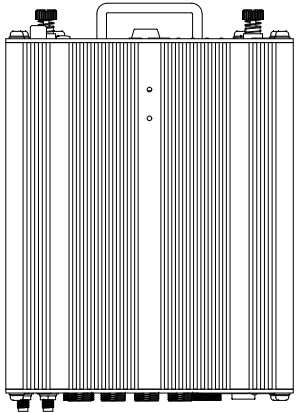
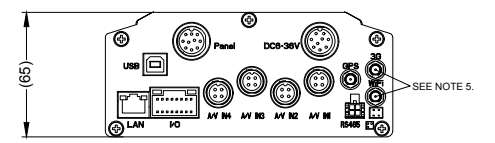
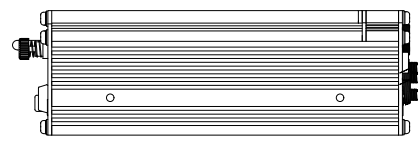
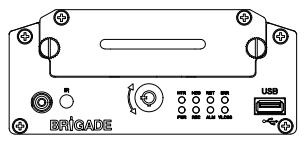
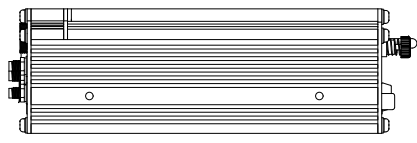
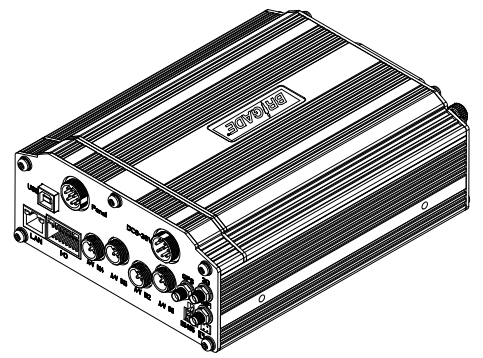
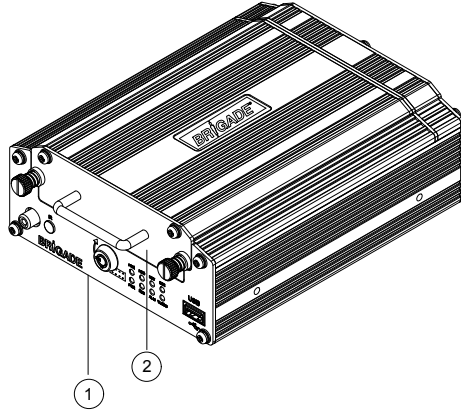
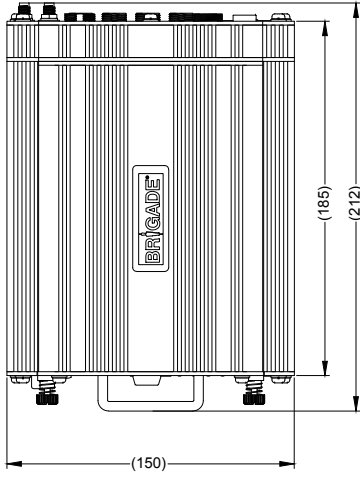

- NOTES:**
1. REFERENCE INSTRUCTION MANUAL FOR FUNCTIONALITY.
 2. FOR PRODUCT LABEL REFER TO LATEST REVISION OF DRAWING: BE-003110-XX-15.
 3. FOR SERIAL NUMBER LABEL REFER TO LATEST REVISION OF DRAWING: BE-003112-XX-15.
 4. ANY CUSTOMER MODIFICATION OF THIS PRODUCT CAUSING SUBSEQUENT FAILURE IS NOT A LIABILITY OF BRIGADE ELECTRONICS GROUP PLC.
 5. 3G AND WIFI CAPABILITIES DEPEND ON MODEL AND AVAILABILITY.

PROPRIETARY NOTICE
 THIS DESIGN AND TECHNICAL INFORMATION APPEARING ON THIS DRAWING IS THE PROPERTY OF BRIGADE ELECTRONICS, AND IS DISCLOSED IN CONFIDENCE. IT IS NOT TO BE COPIED, REPRODUCED, REVEALED TO OR EXPROPRIATED BY OTHERS, EITHER IN WHOLE OR IN PART WITHOUT THE EXPRESS WRITTEN CONSENT OF BRIGADE ELECTRONICS.

BRIGADE®
 www.brigade-electronics.com

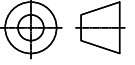
Assembly Pl Approval P.YANG	Approved by B.JOHN	Checked by R.BATES	Drawn by L.PILAY
Angle of Projection  Third Angle	Units mm	Scale N/A	Released 21/07/15
Status RELEASED	MDR-404-500-CU		
Part No 4886	BE-003116-00-15		